

Jabsco

a xylem brand

Technical Data Sheet Par-Max HD Series Freshwater Delivery Pump Model: Q402J-118S-3A

This document provides technical information relating to this specific Jabsco model. General information, references and further resource locations are also included.

Jabsco pumps are designed to be durable and high-performing – capable of providing years of satisfactory service in a variety of marine applications.

Features -

- Heavy Duty, Coated Motor
- Integrated Sealed Pressure Switch
- Efficient, quiet operation
- Self-priming
- Runs Dry without Damage

Contents -

Pump Unit: PARMAX HD4 24V 4GPM 60PSI
(PARMAX HD4 24V 15LPM 4.1BAR)

Port Fittings: 2 x 1/2" (13mm) Straight Hosebarb

Strainer: Inline Quick Connect; 40 Mesh

Trigger Nozzle: Not applicable

Adapter 1: Not applicable

Adapter 2: Not applicable

Hosecoil: Not Applicable

IOM: Included (PN 81000475)

Carton Type: 4 Color Aftermarket

Master Pack Qty: 4



Dimensional Drawing -

Notes:

Inches [mm]
Additional envelope space required to allow port clips to extend, wires to bend, port fittings and hoses, etc.

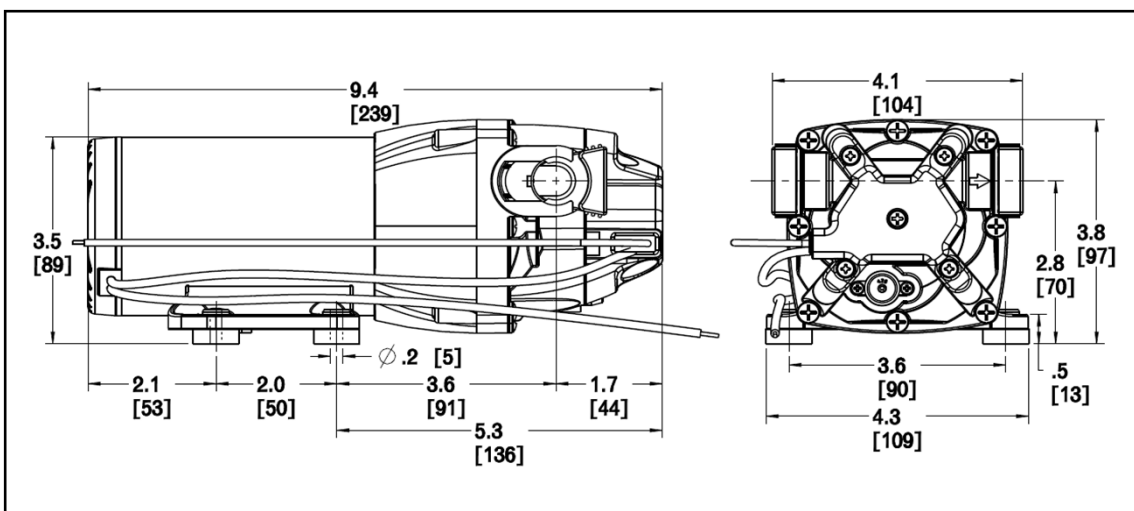

Specifications

General -

Part Number:	Q402J-118S-3A
Aftermarket replacement:	Q402J-118S-3A
Replaces:	82400-0094
(closest matches)	
Application:	Marine Water Pressure System
Design:	4 Chamber Diaphragm Quick Connect Ports TENV Permanent Magnet Motor Noise Dampening Baseplate Thermal Motor Protection (TCO)

Hydraulic Performance (at 12.0 VDC) -

Open Flowrate:	4 GPM open flow (15.1 LPM)
Pressure Switch Cut-Off:	60 PSI (4.1 BAR)
Max Operating Pressure:	60 PSI (4.1 BAR)
Max Inlet Pressure:	30 PSI (2.1 BAR)
Internal Bypass:	Yes
Fluid Temperature Range:	32F - 140F (0C - 60C)
Self-Priming Capability:	Up to 8ft (2.4m) dry prime
Run-Dry Capable:	Yes

Compliance -

CE:	Yes
RCM:	Yes
ISO 8846 Ignition Protected:	Yes
Country of Origin:	China
HTS Code:	8413.50.0050

Materials (*designates wetted path) -

Upper Housing*:	Fiber reinforced polypropylene
Lower Housing:	Cast Aluminum
Check Valve Retainer*:	Polypropylene
Diaphragm*:	Santoprene
Check Valves*:	EPDM
Switch diaphragm*:	EPDM
Bypass Diaphragm*:	EPDM
PH Seals*:	EPDM
PH Fasteners:	Stainless Steel
Baseplate:	Plastic w/rubber feet
Motor Casing:	Cast Aluminum; Coated Steel

Electrical Performance (at 12.0VDC) -

Nominal Voltage:	24 VDC
Voltage Range:	18 VDC - 27.2 VDC
Max Current Draw:	6 Amps @ 60 PSI (4.1 BAR)
Fuse Size:	10 Amps (not included)
Duty Cycle:	Intermittent (See heat-rise chart)
Leads:	12" (305mm), 14 AWG (2.5mm ²)
Wire Connection:	Stripped Wire

Other Information -

Operating Environment:	Marine
Ambient Temp Range:	32F - 140F (0C - 60C)
IP Rating:	IPX6
Carton Dimensions:	15.5x6x5.5" (394x152x140mm)
Pump Weight:	5.6 lbs (2.5 kg)
UPC Code:	671880841900

Flowcurve -

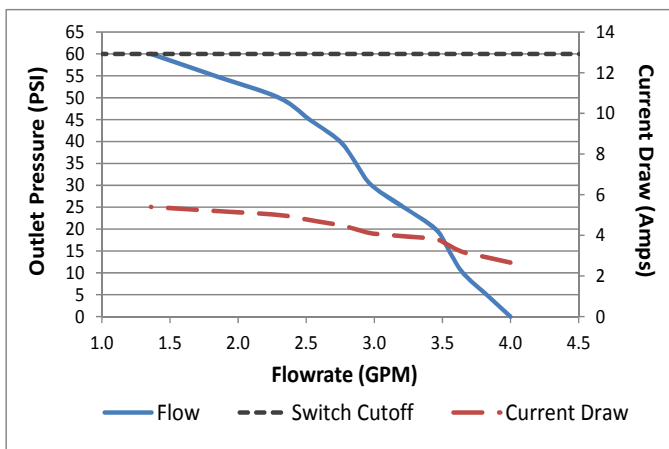

Representative curve of unit operated at nominal voltage
Performance will vary somewhat unit to unit
Switch cut-off represents the point on the flowcurve at which the integrated pressure switch will turn off the pump

Heat-Rise -

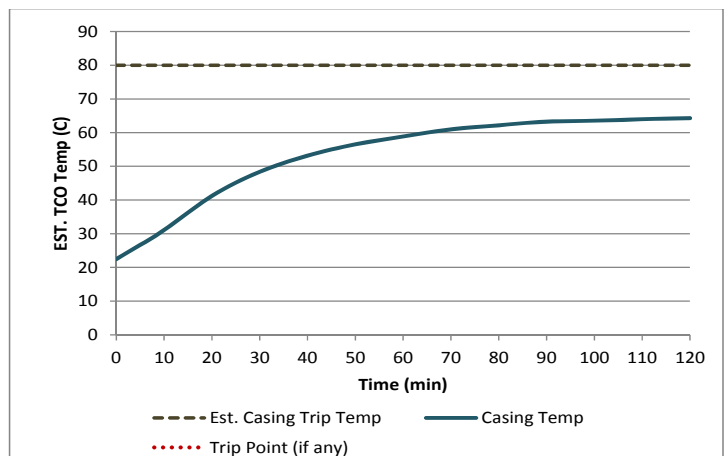

Tested @ ambient temp of 70F (21.1C) @ max run pressure
Trip point shown is casing temp at time of TCO trip
If there is concern about the ability of the pump to run continuously for long periods of time then in-application testing is highly recommended.

Pump Service Kits & Spares

Item	Part Number	Contents
1. Port Clips	30647-1000	2 port clips per kit
2. Switch Kit	16470-0060	Switch assembly w/wire leads, switch diaphragm, and heat shrink butt connectors
3. Check Valve Assembly	18753-0731	Check valve housing with suction and discharge check valves installed
4. Diaphragm/Drive Assembly	18753-0730	Wobble plate/diaphragm assembly
5. Baseplate/Mounting Feet	18753-0729	Baseplate w/rubber mounting feet installed

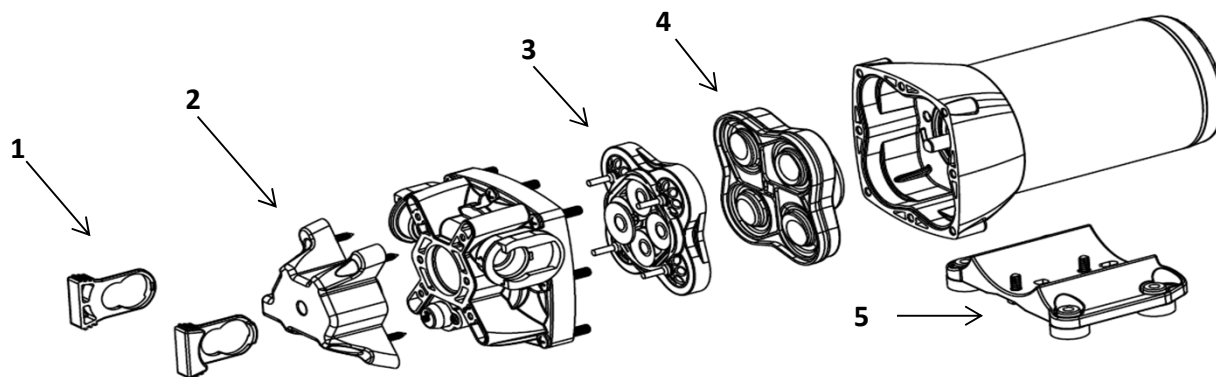

Accessories (see website for further info)

Item	Kit PN	Description	Notes
Washdown Trigger Nozzles	30703-1000	Regular	Quick release interface, includes EU & US Adapters
	30703-1001	Deluxe (built-in flow adjustment)	Quick release interface, includes EU & US Adapters
Washdown Trigger Nozzle Hose Adapters	34012-8001	US Garden Hose Thread	3/4" Female GHT Adaptor for trigger nozzle
	98022-0001	Crimp (EU Style)	Adapts trigger nozzle to crimp onto a hose
Washdown Hose Coils	31910-1225	Regular	25' x .35" ID (6.2m x 9mm) Hosecoil
	31910-1226	Deluxe (Heavy duty/larger ID)	25' x 1/2" ID (6.2m x 13mm) Hosecoil
Freshwater Delivery System Accumulator Tanks	30573-0003	0.65 Liter tank, reinforced plastic	Used to smooth out flow, reduce cycling for freshwater water pressure systems. See website for more details. Do not use with variable speed
	30573-0000	1 Liter tank, reinforced plastic	
	18810-0000	2 Gal tank, coated steel	
Strainers (Required in all applications)	46400-0030	In-line, Bayonet style, QC	QC = Quick Connect Place before inlet of the pump so as to filter the incoming water and protect the check valves and pressure switch from getting clogged Other options available available as well. See website for more detail.
	46400-9500	90 degree 3-5 GPM QC	
	46400-0711	90 degree 6 GPM QC	
	46400-0003	In-line, 3/8" Hosebarb	
	46400-0002	In-line, 1/2" Hosebarb	
	46400-0000	In-line, 3/4" Hosebarb	
Port Fittings	1877K-2222S	2-5 GPM Models: 1/2" Hosebarb	Part numbers listed are straight port configuration Quantity 2 per except GHT GHT = Garden Hose Thread (qty 1) Threaded = NPS Threads For 90 degree Elbow models replace the S with an E Not all models have 90 degree equivalents
	1877K-2242S	2-5 GPM Models: 1/2" Threaded	
	1877K-3222S	2-5 GPM Models: 3/4" Hosebarb	
	1877K-3211S	2-5 GPM Models: 3/4" GHT	
	1877K-3242S	6 GPM Models: 1/2" Threaded	
	1877K-3322S	6 GPM Models: 3/4" Hosebarb	
	1877K-3311S	6 GPM Models: 3/4" GHT	
Washdown Deck Fitting	31911-0000	Stainless Steel Deck Fitting	Quick release mount for washdown hose on deck
Aquaflita (water pressure systems)	59000-1000	Freshwater filtration system	EU only
	59000-0000	Replacement cartridge	EU only

Marine Application Notes

Washdown -

Used for on-demand spray to clean anchors, buoys, fishing areas, etc. Typically the higher the flow and the higher the pressure the better. Sometimes used with a Y valve to serve a dual purpose of livewell circulation. Common accessories include strainers, trigger nozzles, hoses, and deck mount fittings. Sometimes plumbed off of the livewell inlet to reduce number of thru-hull fittings.

Freshwater Delivery Pumps -

Installed to provide on-demand flow and pressure of freshwater to galleys, showers, washing machines, etc. Typical rule of thumb for sizing is 1 GPM per outlet. 40-60 psi (2.8 - 4.1 Bar) options provide similar pressure to that in a home on land. These pumps are equipped with a bypass which enables smoother flow and decreases cycling. Common accessories include strainers, water pressure inlet regulators, and accumulator tanks.

Shower-Drain/Livewell/General Purpose -

These pumps are configured without a pressure switch and are used for a variety of different purposes including removal of drain water from showers or the circulating/transfer of water in bait tanks.

Auxiliary Bilge/General Purpose -

Configured without a pressure switch and also with elastomers specifically chosen to provide greater chemical compatibility and protection against fluids such as diesel fuel and motor oils.

Available Jabsco Options

In addition to the unit described in this data-sheet Jabsco also offers the following configurations (will vary somewhat by region) and options to suit above applications:

Voltages:	12 & 24 VDC options (for AC options please lookup Flojet products)
Flowrate Range:	1 - 6 GPM (3.8 - 22.7 LPM)
Switch Setting Range:	25 - 70 PSI options (1.7 - 4.8 Bar)
Pump Configurations:	Washdown ("kit" versions include a hose-coil) Freshwater Delivery Pumps Shower-Drain/Livewell/General-Purpose Pumps Bilge/General Purpose Pumps
OEM/Special Options:	We can configure specific product or kitting levels upon request. Minimum annual volume requirements will apply. Please send us an enquiry and we will evaluate.

Installation and Operation

For guidance on proper installation and operation of this pump, as well as for any warnings or cautions involving use, please consult the appropriate IOM for the pump. Printed IOM's are supplied with the pumps and are also available online..

Resources & Contact Information

IOM:	On website; hard copies with pumps	Customer Service:	Refer to contact info at bottom of page
Warranty:	Information included in IOM	Website:	www.xylem.com/Jabsco

Note: JabscoShop.com, can be a good resource to purchase direct items such as low use replacement parts. However, the best way to find our product is through our extensive and knowledgeable network of distributors, dealers, and retailers.

Note: Specifications provided for guidance only. We reserve the right to change specifications without prior notice.

USA 17943 Cowan, Irvine, CA 92614
Tel: +1 949 608 3900

JPN 3-21-10, Shin - Yokohama Kohoku-ku, Yokohama 222
Tel: +39 039 685 2323

UK Bingley Road, Hoddesdon, Herfordshire, EN11 0BU
Tel: +44 (0) 45 475 8906

IT Via Tommaseo, 6, 20059, Vimercate, Milano
Tel: +39 (0) 39 685 2323

DE Oststrasse 28, 22844 Norderstedt
Tel: +49 (0) 40 535373-0

AU 2/2 Capicure Dr, Eastern Creek NSW 2766
Tel: +61 2 9832 6200

PN: DSQ402J118S3A
REVISION: 1/13/2020

www.xylem.com/jabsco

